

RANGE DIGISENS

NEPHELOMETRIC TURBIDITY

Optical technology for optimized measures

- IR optical sensor with optical fibre
- Range : 0 to 4000 NTU or 0-4500 mg/L
- Robust and waterproof (IP68)
- Ultra low-power consumption
- Digital output Modbus RS-485
- Nephelometry measurement



Application :

- Urban wastewater treatment (inlet/ outlet controls)
- Sanitation network
- Industrial effluent treatment
- Surface water monitoring
- Drinking water

Optical technology :

The measure principle is based on IR nephelometry / 850 nm. The sensor can be calibrated with a formazine standard solution.

The NTU sensor integrates a low-cost optical technology, with a very few maintenance and no consumables.

Digital communication :

The PONSEL sensor can be connected to any types of transmitters, display units, controllers or data loggers with Modbus RS-485 or SDI-12 inputs. The optical sensor saves its calibration data for better measures management.

Integrated transmitter :

All data concerning calibration, history, users and measures are directly treated within the NTU sensor and transmitted via RS-485 or SDI-12.

Physical characteristics :

Compact, robust and light, the PVC sensor allows a handheld or fixed unit application.

Technical characteristics :

Measures	
Measure principle	Diffusion IR at 90°
Measure ranges	5 to 4000 NTU in 5 ranges: <ul style="list-style-type: none"> ▪ 5 – 50 NTU ▪ 5 – 200 NTU ▪ 5 – 1000 NTU ▪ 5 – 4000 NTU ▪ AUTOMATIC 0 to 4500 mg/L Calibration : Range 0-500 mg/L according to NF EN 872 Range >500 mg/L according to NF T 90 105 2
Resolution	0,01 to 1 NTU - mg/L
Accuracy	< 5% of the reading
Working temperature	0°C to + 50°C
Measure of temperature	Via CTN
Stocking temperature	-10°C to + 60°C
Signal interface	Modbus RS-485 (standard) and SDI-12 (option)
Maximum refreshing time	< 1 second
Sensor power-supply	5 to 12 volts
Electric consumption	Standby : 40 µA Average RS485 (1 measure/seconde) : 820 µA Average SDI12 (1 measure/seconde) : 4,2 mA Current pulse : 500 mA

Sensor	
Dimensions	Diameter : 27 mm; length : 170 mm
Weight	300 g (sensor + cable 3 meters)
Material	PVC, DELRIN, Quartz, PMMA, Polyamide
Maximum pressure	5 bars
Connection	9 armoured connectors, polyurethane jacket, bare-wires or waterproof Fisher connector
Degree of protection	IP68

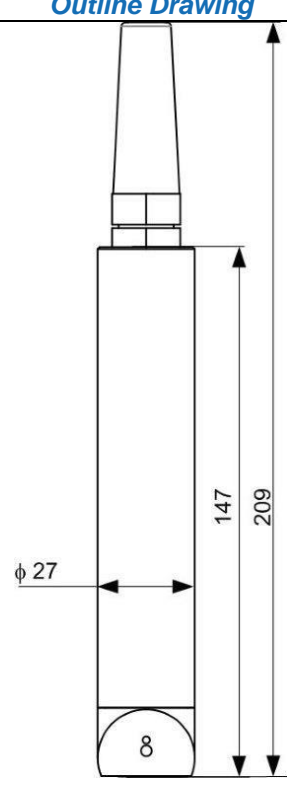
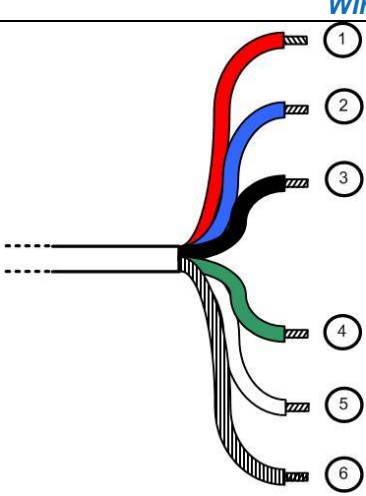
Outline Drawing	Wiring diagram																
																	
	<p>Cable length 15 to 100 meters</p> <table border="1" style="margin-left: auto; margin-right: auto;"> <tr> <td>Red</td> <td rowspan="5">Power supply V+</td> </tr> <tr> <td>Purple</td> </tr> <tr> <td>Yellow</td> </tr> <tr> <td>Orange</td> </tr> <tr> <td>pink</td> </tr> <tr> <td>2 - Blue</td> <td>SDI-12</td> </tr> <tr> <td>3 - Black</td> <td>Power supply V-</td> </tr> <tr> <td>4 - Green</td> <td>B " RS-485 "</td> </tr> <tr> <td>5 - White</td> <td>A " RS-485 "</td> </tr> <tr> <td>6 - Green/yellow</td> <td>Cable shield</td> </tr> </table>	Red	Power supply V+	Purple	Yellow	Orange	pink	2 - Blue	SDI-12	3 - Black	Power supply V-	4 - Green	B " RS-485 "	5 - White	A " RS-485 "	6 - Green/yellow	Cable shield
Red	Power supply V+																
Purple																	
Yellow																	
Orange																	
pink																	
2 - Blue	SDI-12																
3 - Black	Power supply V-																
4 - Green	B " RS-485 "																
5 - White	A " RS-485 "																
6 - Green/yellow	Cable shield																
	<p>Cable length up to 15m</p> <table border="1" style="margin-left: auto; margin-right: auto;"> <tr> <td>1- Red</td> <td>Power supply V+</td> </tr> <tr> <td>2 - Blue</td> <td>SDI-12</td> </tr> <tr> <td>3 - Black</td> <td>Power supply V-</td> </tr> <tr> <td>4 - Green</td> <td>B " RS-485 "</td> </tr> <tr> <td>5 - White</td> <td>A " RS-485 "</td> </tr> <tr> <td>6 - Green/yellow</td> <td>Cable shield</td> </tr> </table>	1- Red	Power supply V+	2 - Blue	SDI-12	3 - Black	Power supply V-	4 - Green	B " RS-485 "	5 - White	A " RS-485 "	6 - Green/yellow	Cable shield				
1- Red	Power supply V+																
2 - Blue	SDI-12																
3 - Black	Power supply V-																
4 - Green	B " RS-485 "																
5 - White	A " RS-485 "																
6 - Green/yellow	Cable shield																

Note:

Never exceed a voltage of 10VDC (absolute maximum rating) on communication lines RS485, A or B, under penalty of irreversible destruction of the transceiver component RS 485.

SDI-12: respect the voltage value described in the associated standard (nominal: 5 VDC)

Always connect ground + shield first.